



(PPA)

Polymer Processing Aids



A little
something
to give you
big ideas!

Kynar® PPA can be used to improve the processing performance of all types of polyolefins including but not limited to: LLDPE, LDPE, HDPE, and PP.



Listed are some articles published on polymer processing aids.

References

V. Vora, J. Gingras, "Increasing Throughput, Reducing downtime", Modern Plastics & Polymers, pp. 190-192 (January 2012)

V. Vora, F. Beaume, "For Best-in-Class Performance", Modern Plastics & Polymers, pp.71-72 (September 2012)

V. Firdous, PP. Tong. "Sharkskin Melt Fracture: Effect on LLDPE Film, Properties", Journal of Plastic Film & Sheeting, Vol 8 – October 1992 pp 333 – 340







J. Gingras, F. Beaume, P. Elmerch, J. Laffargue, "Polyvinylidene Fluoride Based Polymer Processss Aids, Their Evaluation and Conditioning Procedures," Tappi Proceedings, Indianapolis, IN; September 2004

Recommendations for Masterbatch Preparation

Masterbatches should not have a Kynar® PPA content above 5% since this can lead to poor dispersion. A level around 2% is desirable. The table below can be used to determine the percentage of masteratch to be included in the final mixture to obtain the required level (in ppm) of Kynar® PPA.

Kynar® resin ppm targeted in final mixture	Use of masterbatch at...				
	1%	2%	3%	4%	5%
200	Add 2%	Add 1%	Add 0.67%	Add 0.5%	Add 0.4%
400	Add 4%	Add 2%	Add 1.33%	Add 1%	Add 0.8%
600	Add 6%	Add 3%	Add 2%	Add 1.5%	Add 1.2%
800	Add 8%	Add 4%	Add 2.67%	Add 2%	Add 1.6%
1000	Add 10%	Add 5%	Add 3.33%	Add 2.5%	Add 2%

Kynar® PPA resins offer a range of fluorinated processing aids used to improve the manufacturing of:

-  **LLDPE, LDPE, HDPE, PP**
-  **Film products**
-  **Extrusion blow molding**
-  **Pipes and tubing (PEX, HDPE,..)**
-  **Extruded fibers**
-  **Wire and Cable**

Final Product benefits

Kynar® PPA resins bring the following benefits:

- Elimination of Melt fracture (shark skin)
- Improvement of film transparency
- Improvement of smoothness and surface aspect
- Improvement of product appearance
- Improvement of mechanical properties
- Reduction of gels

Processing benefits

Kynar® PPA resins are specially designed to enhance the efficiency of operating conditions:

- Maintenance time reduction
- Reduction of die build-up
- Consistency of production
- Smoother extrusion conditions
- Lower energy consumption
- Reduction of cycle times and quicker transition
- Reduction of potential negative interaction with other film additives such as antiblock and HALS
- Reduction of extruder torque
- Reduction of polymer critical shear rate

Conditions of use

Kynar® PPA resins are mainly used as an additive at 150 -1200 ppm levels to overcome the processing problems encountered with polyolefins.

For such low level of content, it is highly recommended to use Kynar® PPA in the form of a masterbatch for an accurate and a uniform dosing.

Most Kynar® PPA resins are safe for applications involving contact with food articles and meet USA FDA and European food contact regulation.

→ **Kynar® PPA** improves surface defect

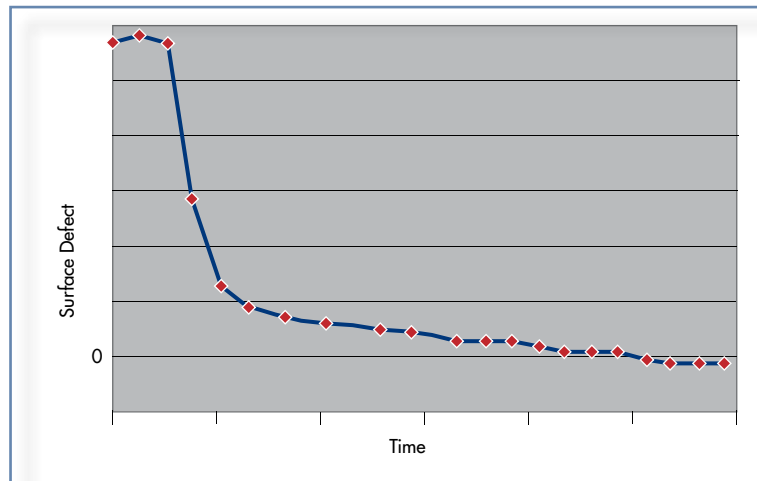

→ **Kynar® PPA** reduces unwanted die build-up

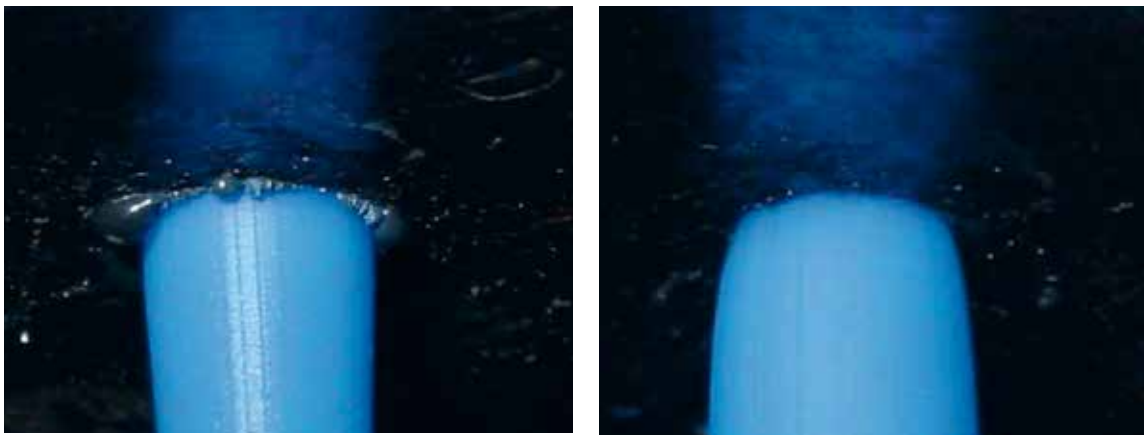

→ **How to use Kynar® PPA**

The two main requirements to get the best out of Kynar® PPA products are:

- a good dispersion;
- a uniform dosing at the typical low concentration level needed with Kynar® PPA.

For a converter, this is achieved by using:

- either a resin that already contains Kynar® PPA;
(many resin producers propose polyolefin grades which contain Kynar® PPA with appropriate and uniform dosage and good dispersion);
 - or a masterbatch:
 - containing typically from 1% to 5% of Kynar® PPA;
 - which can be diluted into their standard resin;
- (many masterbatch manufacturers propose PPA masterbatches based on Kynar® PPA).

→ **Technical and sales support for Kynar® PPA**

From process improvements to product visuals, Arkema has dedicated equipment and field personnel able to bring technical assistance to achieve complete solutions to challenging issues.

BENEFITS OF KYNAR® PPA

Today neither poor appearance nor reduced output is acceptable when extruding polyolefins, but both problems can be easily solved.

By eliminating the surface defects and allowing a higher operating output, Kynar® PPA improves both the quality and profitability of the extrusion process:

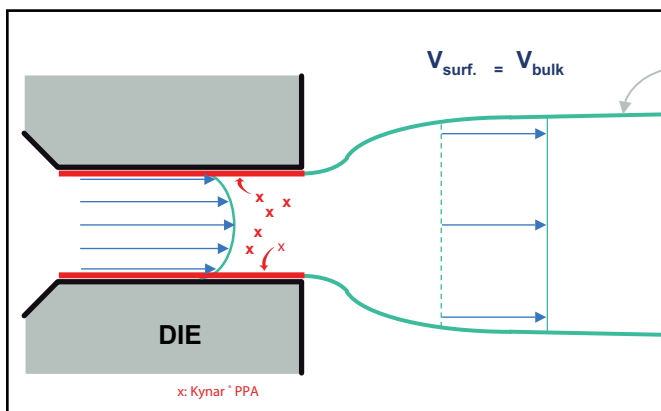
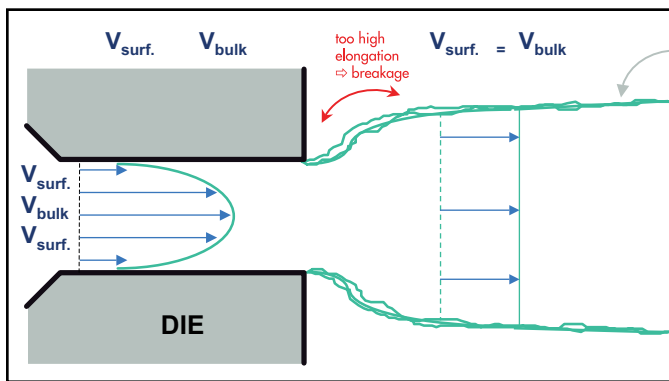

Kynar® PPA
eliminates melt-fracture
also called shark-skin
(LLPE blown film)

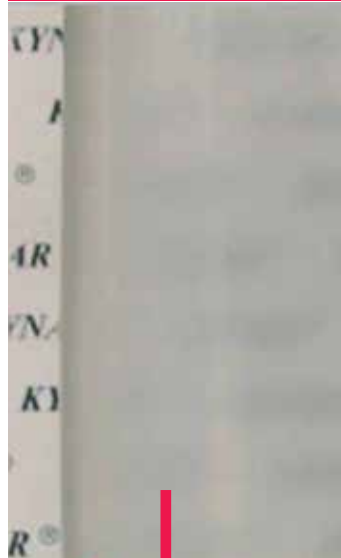

Kynar® PPA
improves the surface
appearance and the
smoothness.



→ Typical results of **Kynar® PPA** (@450 ppm) in linear low density polyethylene blown film extrusion

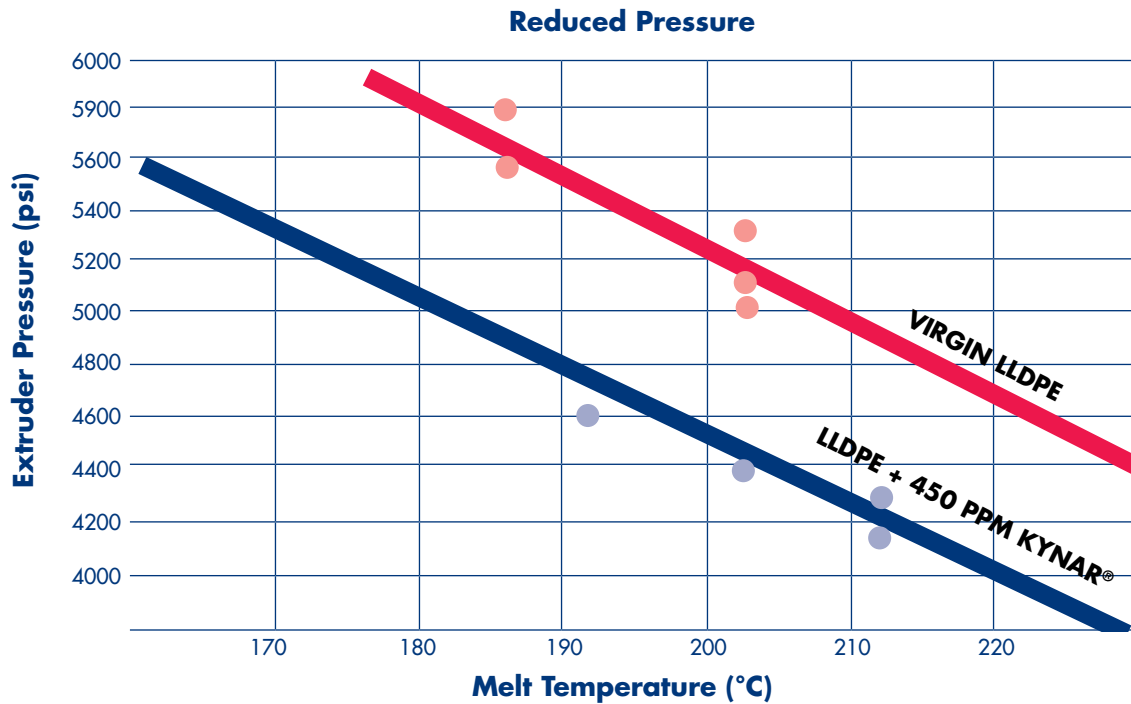

Higher Output, Reduced Power

	Melt Temp (°C)	Screw Speed (RPM)	Output (lbs/hr)	Required Power (Amps-% of Max)	Extruder Head Pressure (PSI)	Film Quality
LLDPE (control) No Additive	196	34	66(a)	17	5,400	Clear no melt fracture
LLDPE (control) No Additive	200	80	150	22	5,500	Continuous melt fracture
LLDPE with 450 ppm Kynar® PPA Additive	200	80	155(b)	18	4,300	Clear no melt fracture
LLDPE with 450 ppm Kynar® PPA Additive	200	102(c)	204	22	5,000	Clear no melt fracture

(a) Onset of melt fracture observed above this output level.

(b) No attempt was made to increase output.

(c) Maximum screw speed on available equipment.



Select from several grades of Kynar® PPA to match process requirements

Best PPA selection is based on:

- Temperature of the extrusion or molding process and the resulting polymer melt temperature**
- Melt index of the polyolefin that requires the use of a PPA**
- Shear rate of the process**
- Need for a synergist formulation based on other additives to the polymer being processed**

Consult your Arkema technical representative to choose from the following grades of Kynar® PPA (Kynar® PPA grades are available as either pellet or powder depending on the preference of the masterbatch producer.)

Kynar Flex® 3120-50; 3121-50
Kynar Flex® 2800-20; 2821-00
Kynar Flex® 2800-00; 2801-00

Kynar® 5300; 5301
Kynar® 8600; 8601
Kynar Superflex® 2500-20; 2501-20

For more information on Kynar® PVDF

Phone: 1-800-Kynar-50 (1- 800-596-2750)

Fax: 1-610-205-7497

The statements, technical information and recommendations contained herein are believed to be accurate as of the date hereof. Since the conditions and methods of use of the product and of the information referred to herein are beyond our control, ARKEMA expressly disclaims any and all liability as to any results obtained or arising from any use of the product or reliance on such information; NO WARRANTY OF FITNESS FOR ANY PARTICULAR PURPOSE, WARRANTY OF MERCHANTABILITY OR ANY OTHER WARRANTY, EXPRESSED OR IMPLIED, IS MADE CONCERNING THE GOODS DESCRIBED OR THE INFORMATION PROVIDED HEREIN.

The information provided herein relates only to the specific product designated and may not be applicable when such product is used in combination with other materials or in any process. The user should thoroughly test any application before commercialization. Nothing contained herein constitutes a license to practice under any patent and it should not be construed as an inducement to infringe any patent and the user is advised to take appropriate steps to be sure that any proposed use of the product will not result in patent infringement. See SDS for Health & Safety Considerations. Arkema has implemented a Medical Policy regarding the use of Arkema products in Medical Devices applications that are in contact with the body or circulating bodily fluids: (<http://www.arkema.com/en/social-responsibility/responsible-product-management/medical-device-policy/index.html>).

Arkema has designated Medical grades to be used for such Medical Device applications. Products that have not been designated as Medical grades are not authorized by Arkema for use in Medical Device applications that are in contact with the body or circulating bodily fluids. In addition, Arkema strictly prohibits the use of any Arkema products in Medical Device applications that are implanted in the body or in contact with bodily fluids or tissues for greater than 30 days. The Arkema trademarks and the Arkema name shall not be used in conjunction with customers' medical devices, including without limitation, permanent or temporary implantable devices, and customers shall not represent to anyone else, that Arkema allows, endorses or permits the use of Arkema products in such medical devices. It is the sole responsibility of the manufacturer of the medical device to determine the suitability (including biocompatibility) of all raw materials, products and components, including any medical grade Arkema products, in order to ensure that the final end-use product is safe for its end use; performs or functions as intended; and complies with all applicable legal and regulatory requirements (FDA or other national drug agencies) It is the sole responsibility of the manufacturer of the medical device to conduct all necessary tests and inspections and to evaluate the medical device under actual end-use requirements and to adequately advise and warn purchasers, users, and/or learned intermediaries (such as physicians) of pertinent risks and fulfill any postmarket surveillance obligations. Any decision regarding the appropriateness of a particular Arkema material in a particular medical device should be based on the judgment of the manufacturer, seller, the competent authority, and the treating physician.

© 2015 Arkema Inc. All rights reserved.

Kynar® and Kynar 500® are registered trademarks of Arkema Inc.

Adhelfon® is a registered trademark of Arkema

ARKEMA
INNOVATIVE CHEMISTRY

kynar.com

Arkema Inc.
900 First Avenue
King of Prussia, PA 19406
USA
Tel.: +1 610-205-7000
Fax: +1 610-205-7497
arkema-inc.com

Arkema (China) Investment Co. Ltd.
Shanghai Branch
6/F, Block 1, Life Hub@Daning,
1868 Gonghexin Road,
Shanghai 200072, P.R. China.
Tel: +86 (21) 6147 6888 ext. 215
Fax: +86 (21) 6147 6746
arkema.com

Headquarters: Arkema France
420, rue d'Estienne d'Orves
92705 Colombes Cedex - France
Tel.: +33 (0)1 49 00 80 80
Fax: +33 (0)1 49 00 83 96
arkema.com